



SCALA2



<http://qr.grundfos.com/i/scala2install>

be
think
innovate

GRUNDFOS 

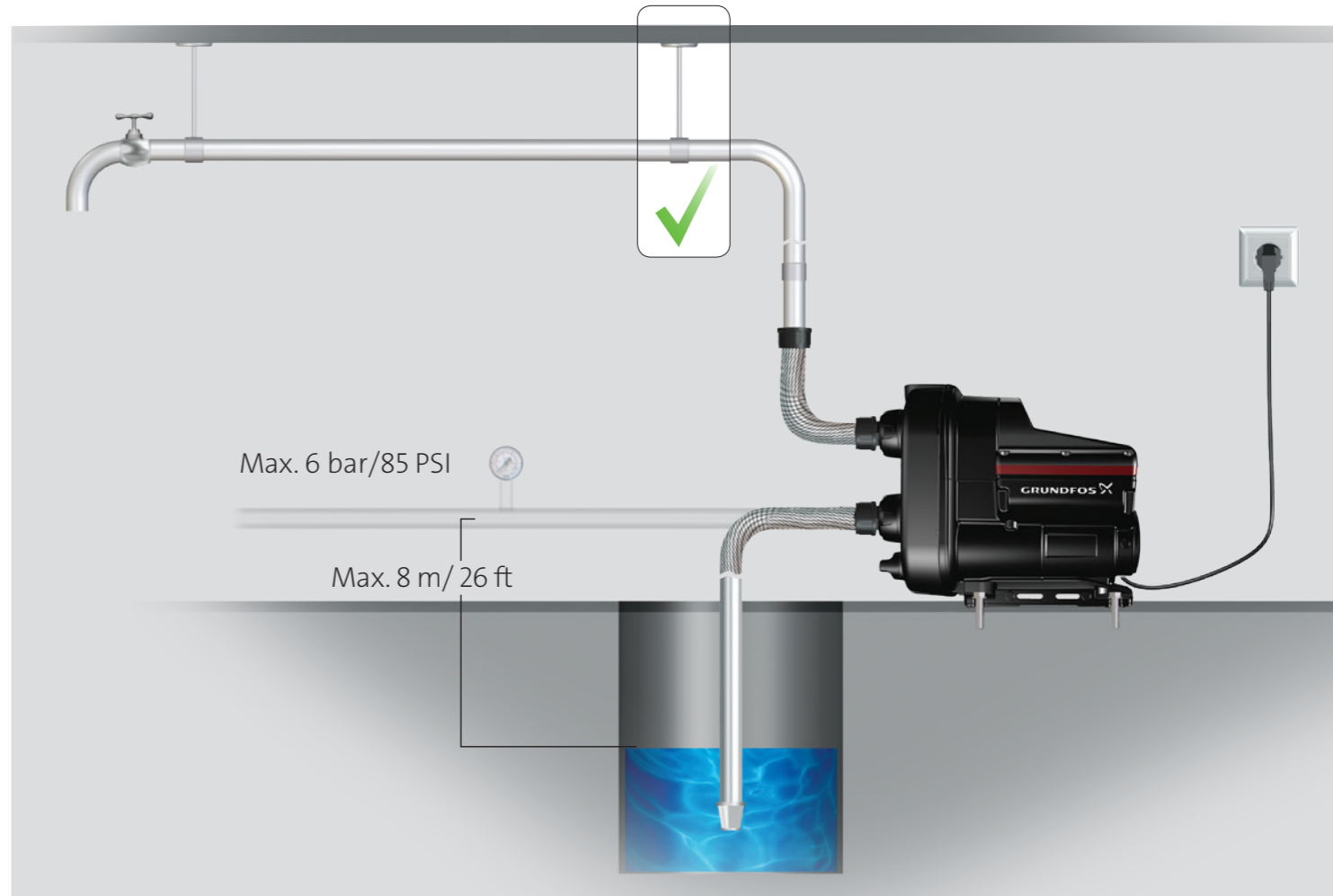
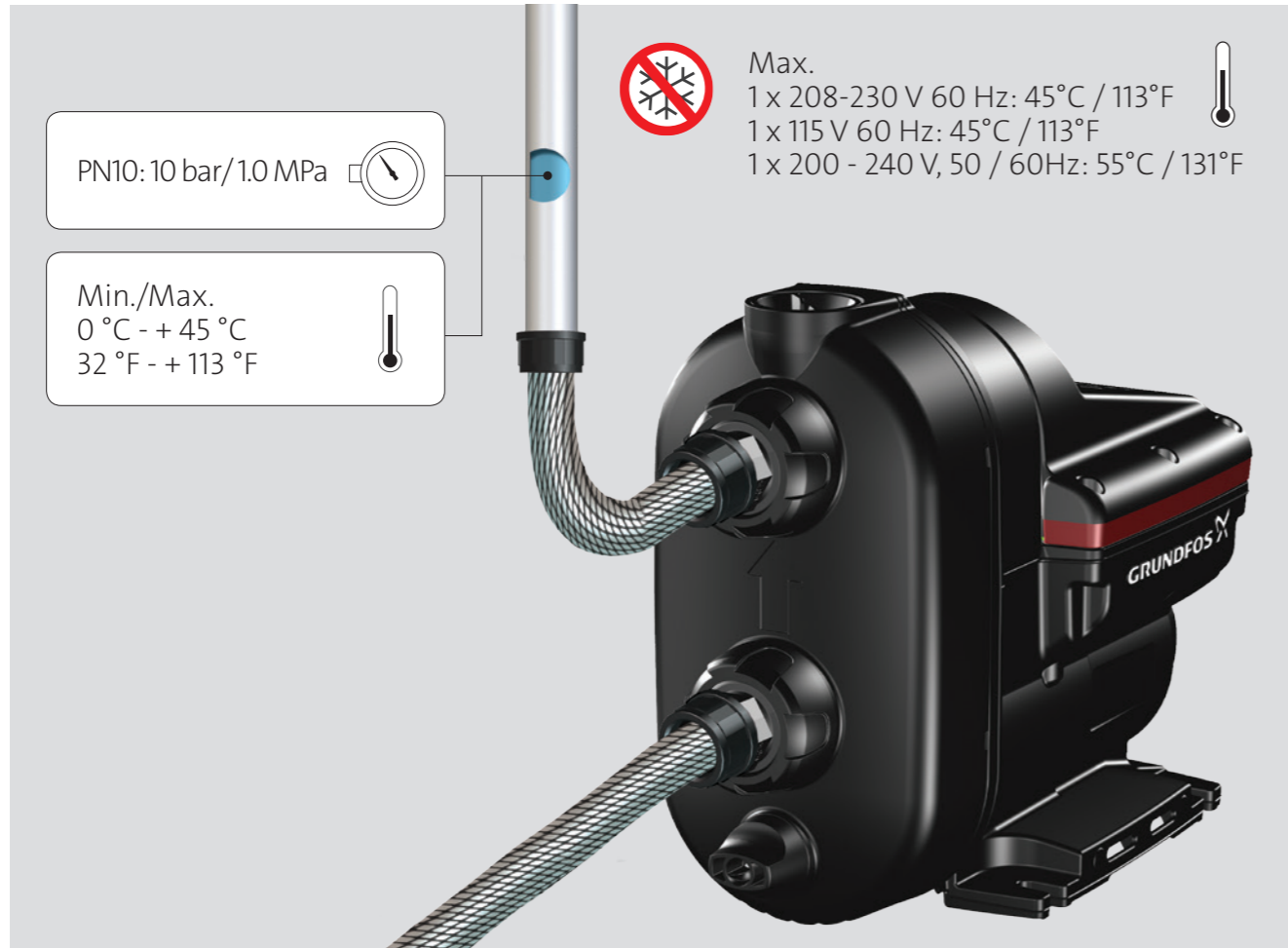
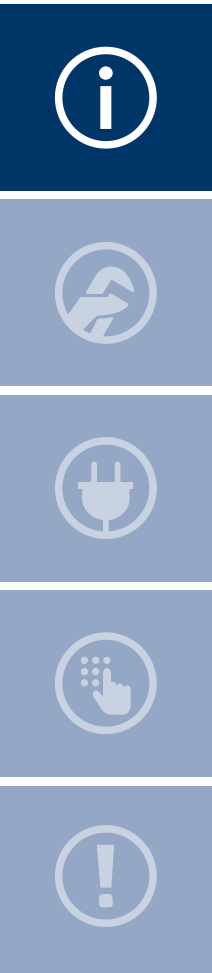

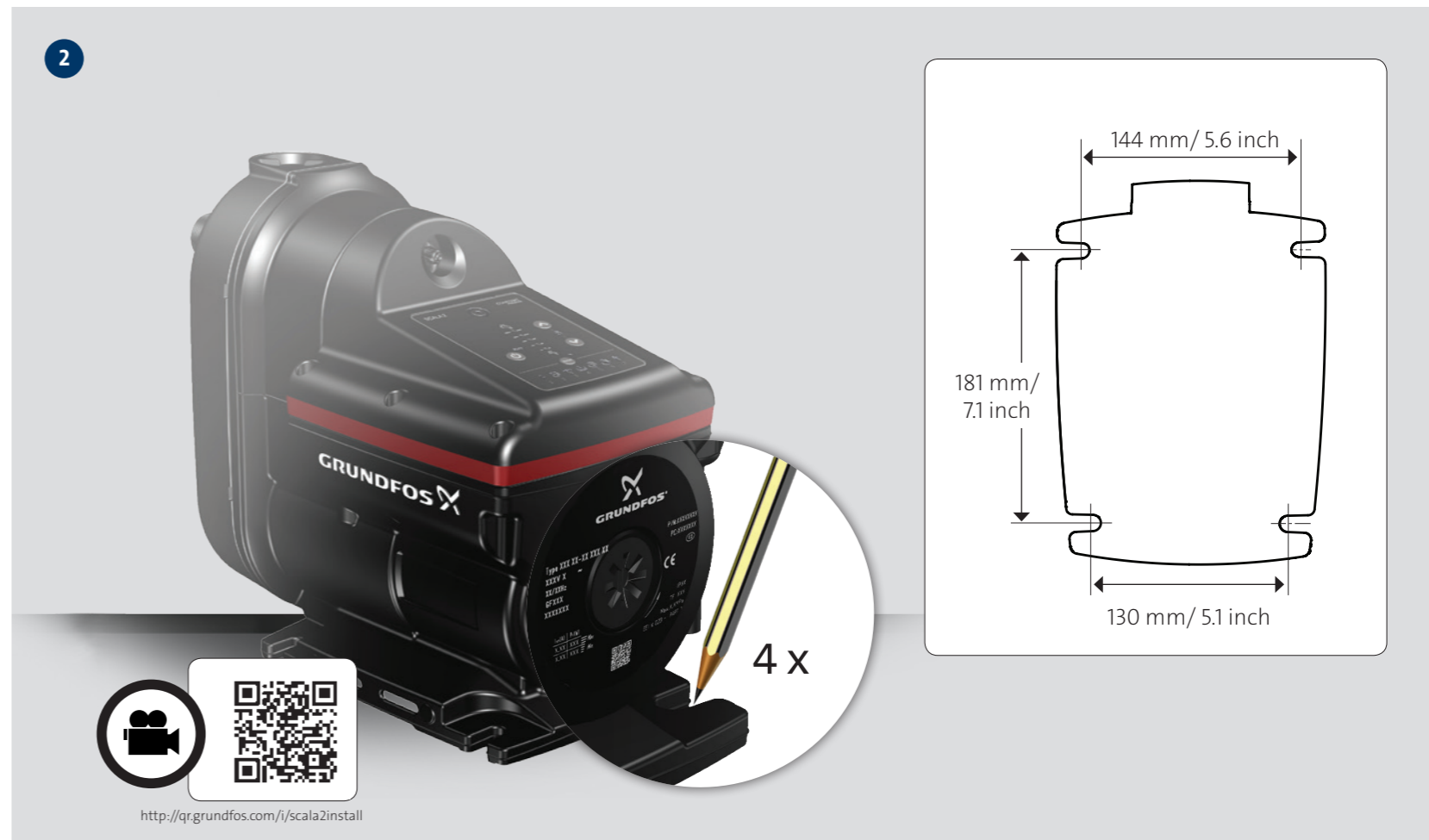
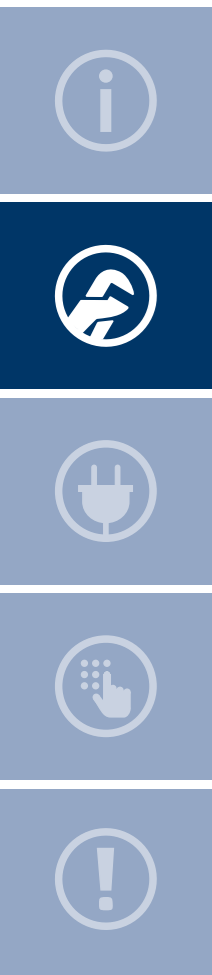

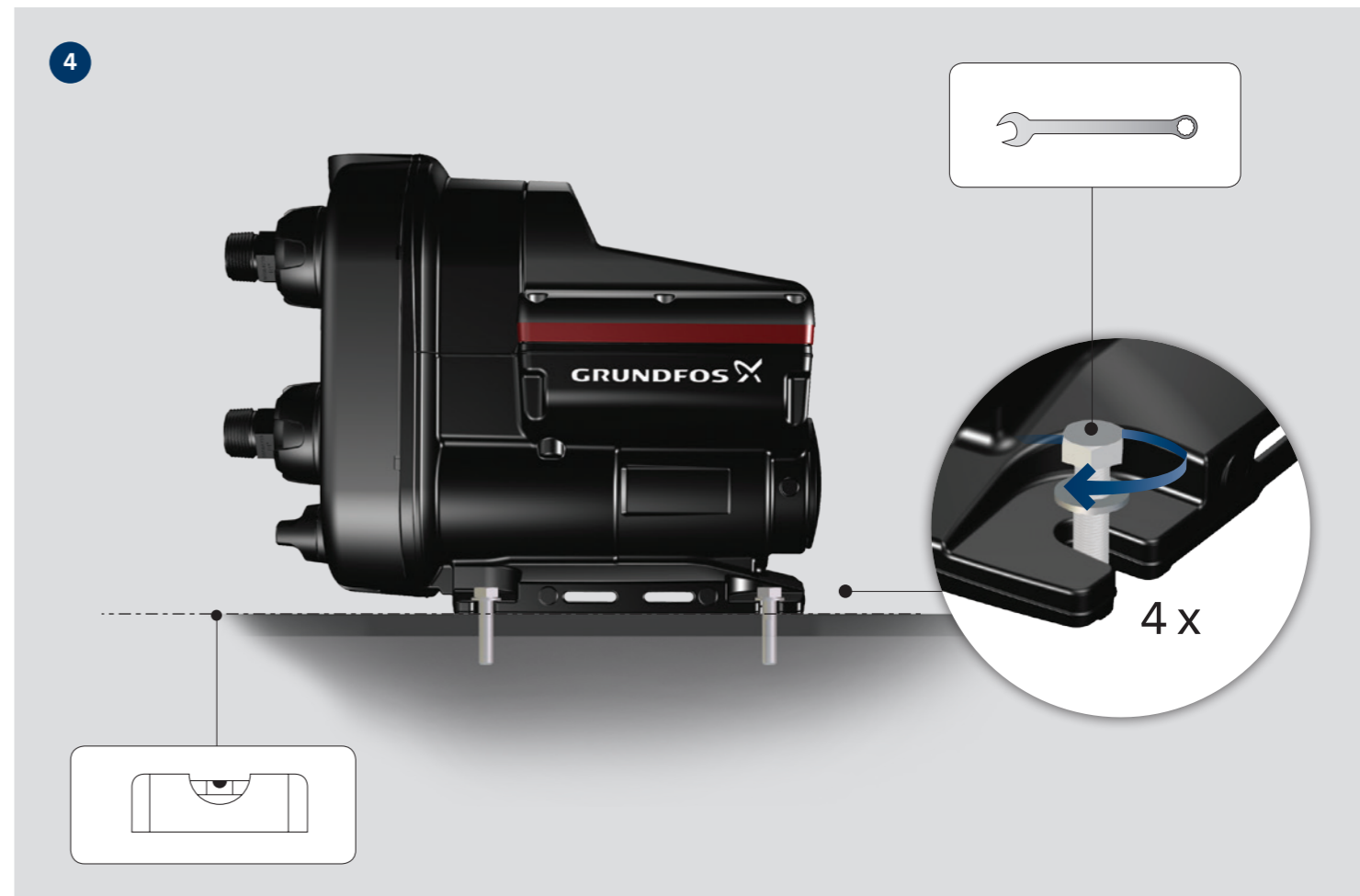
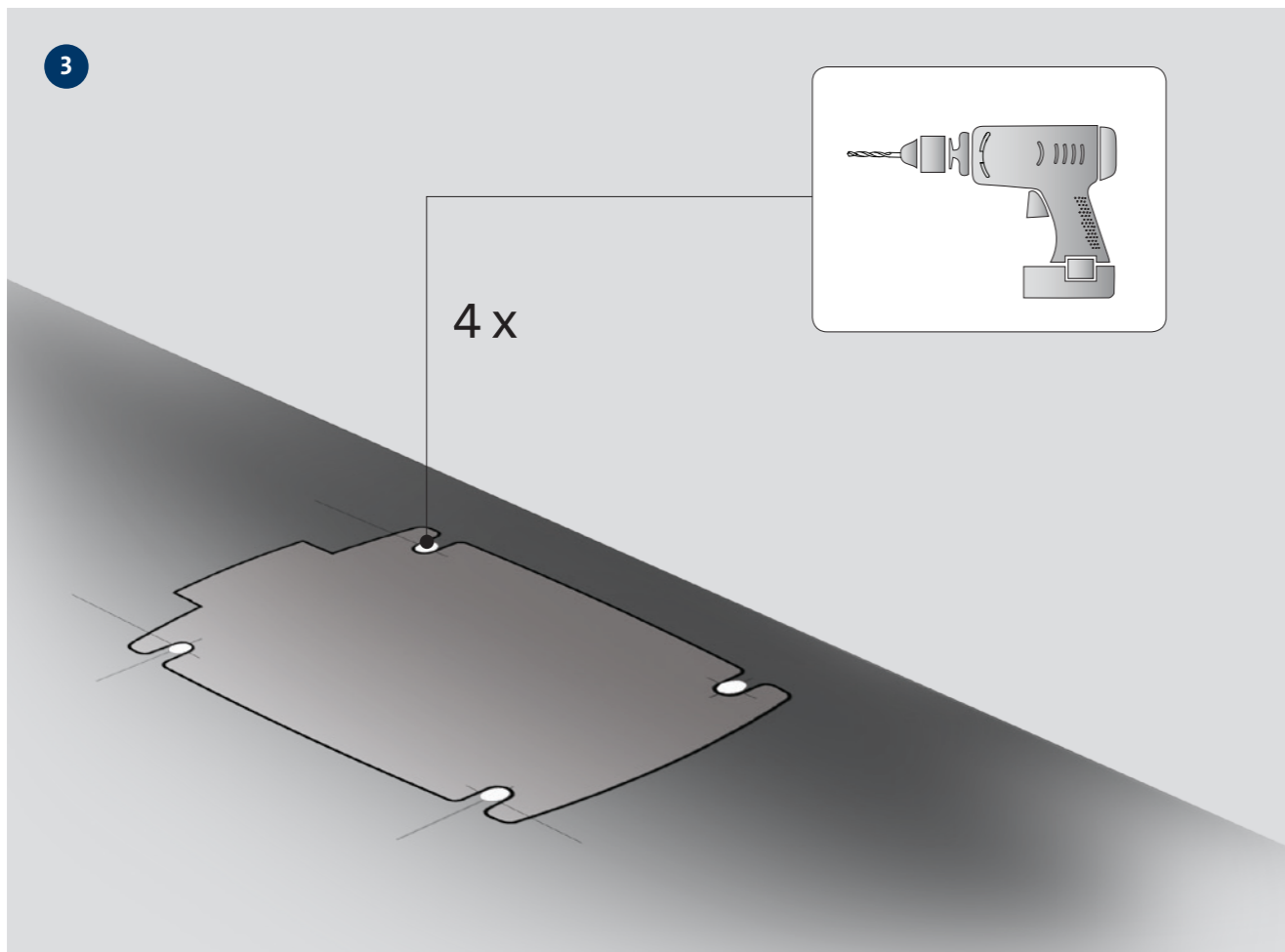
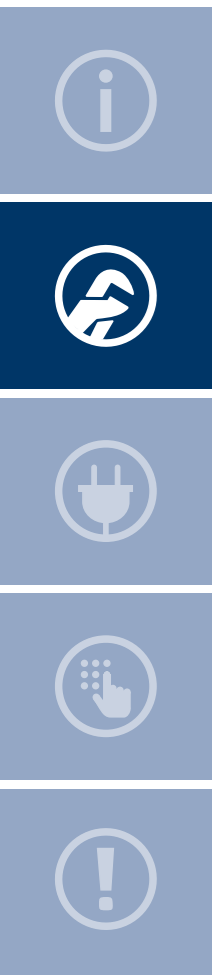

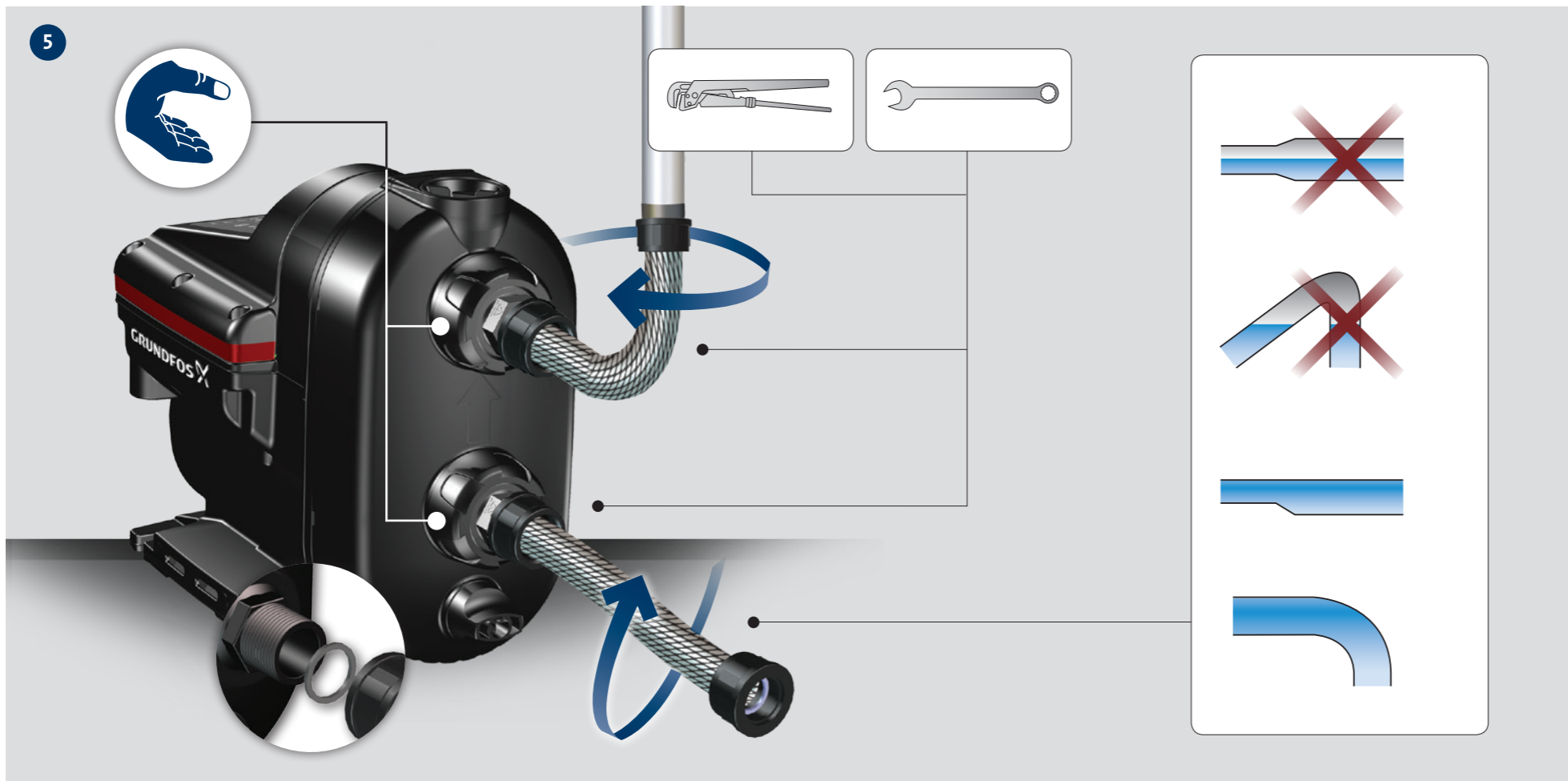
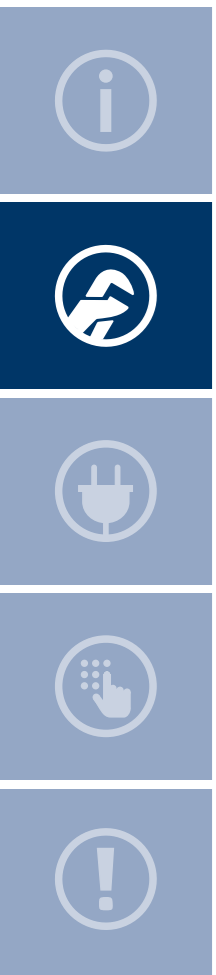

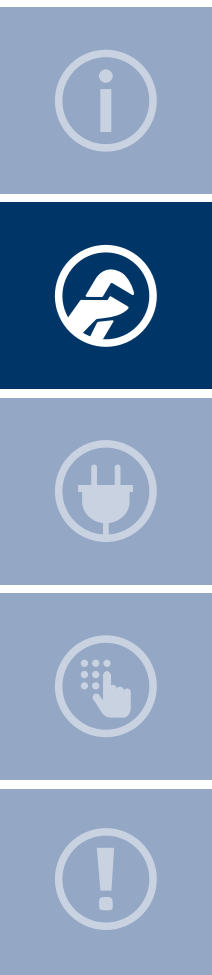

6



1.7 L / 0.45 gal



<http://qr.grundfos.com/i/scala2install>

7



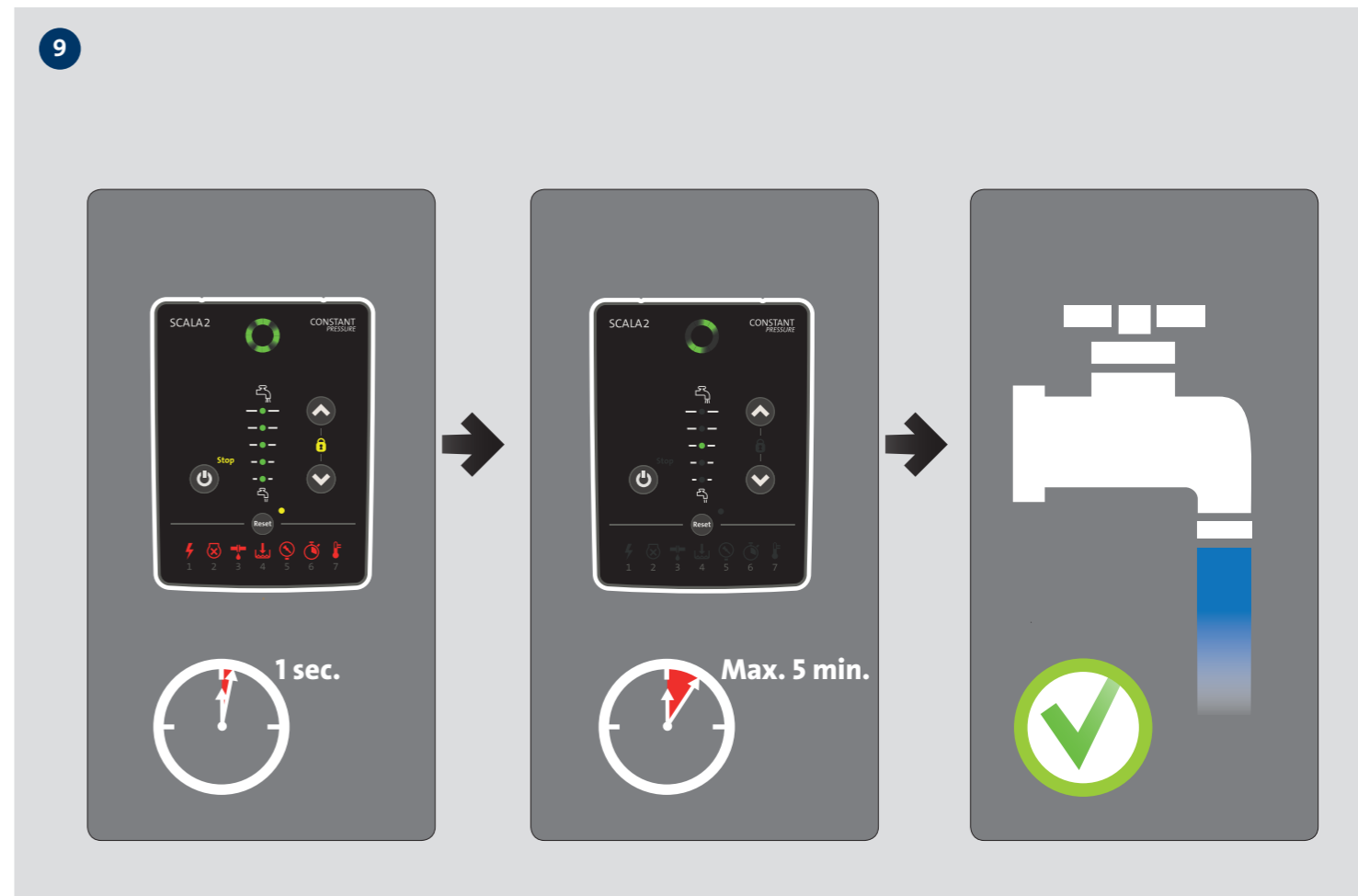
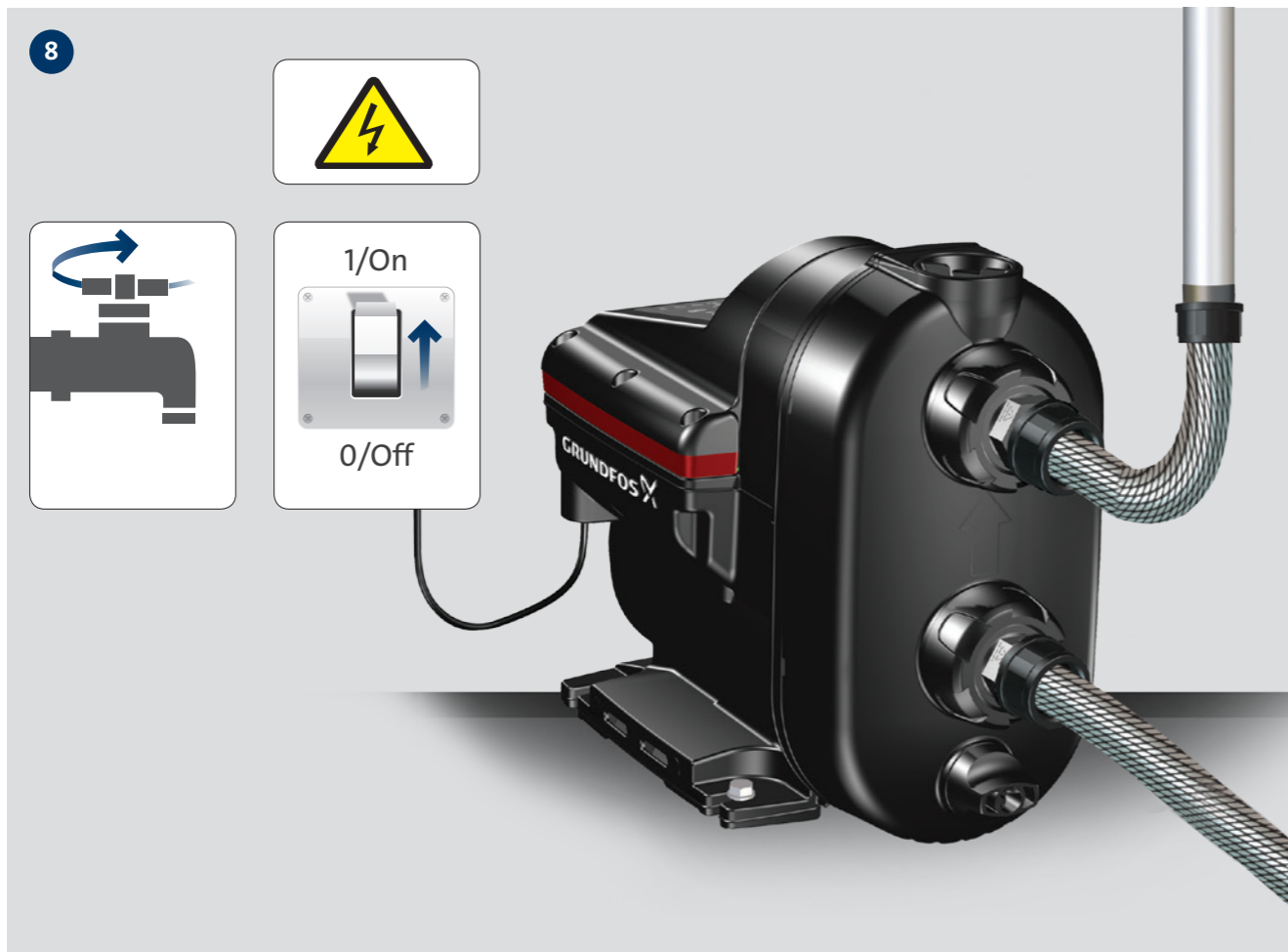
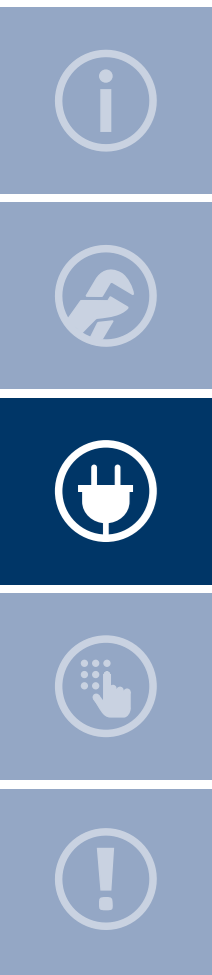

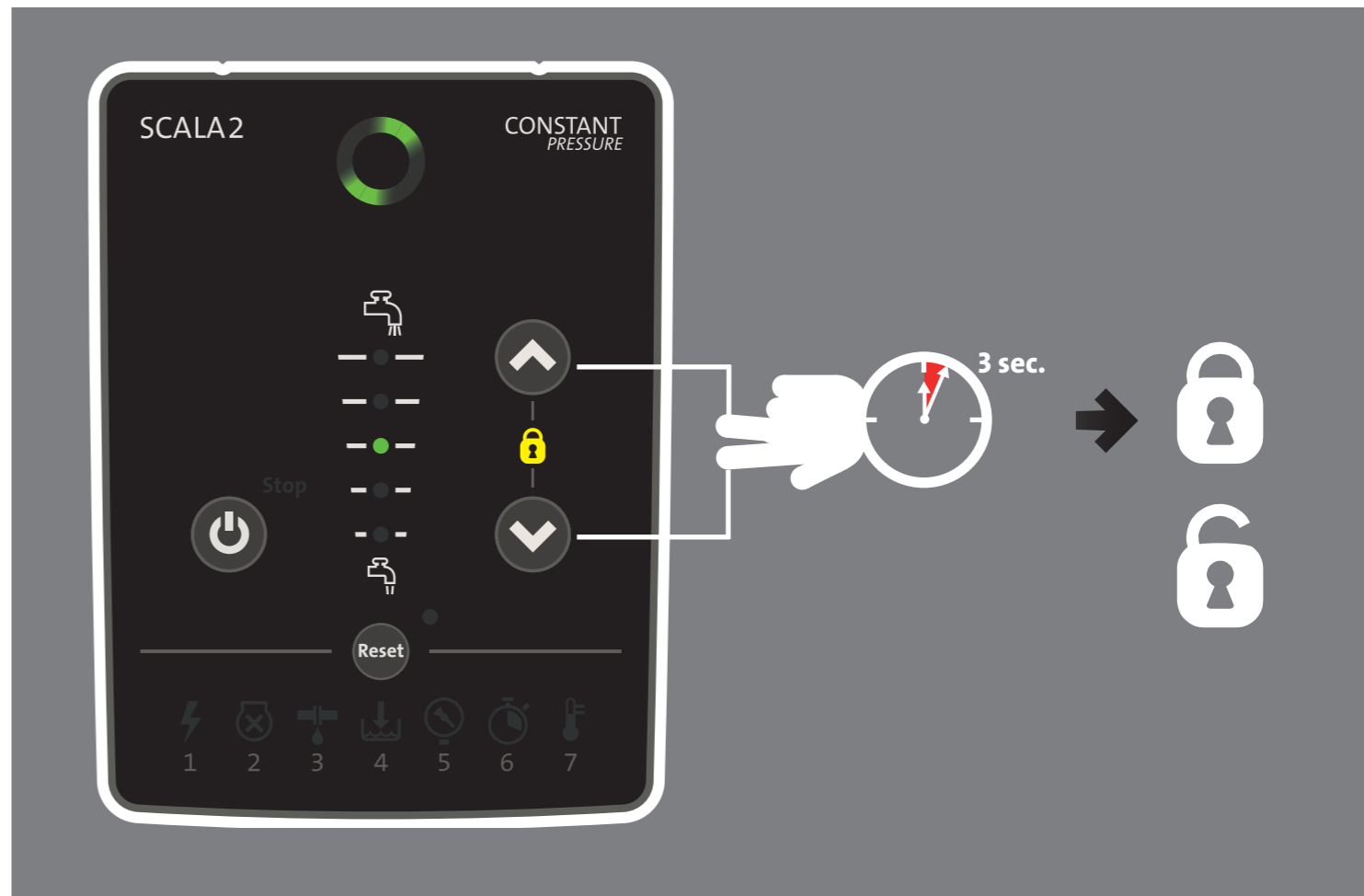
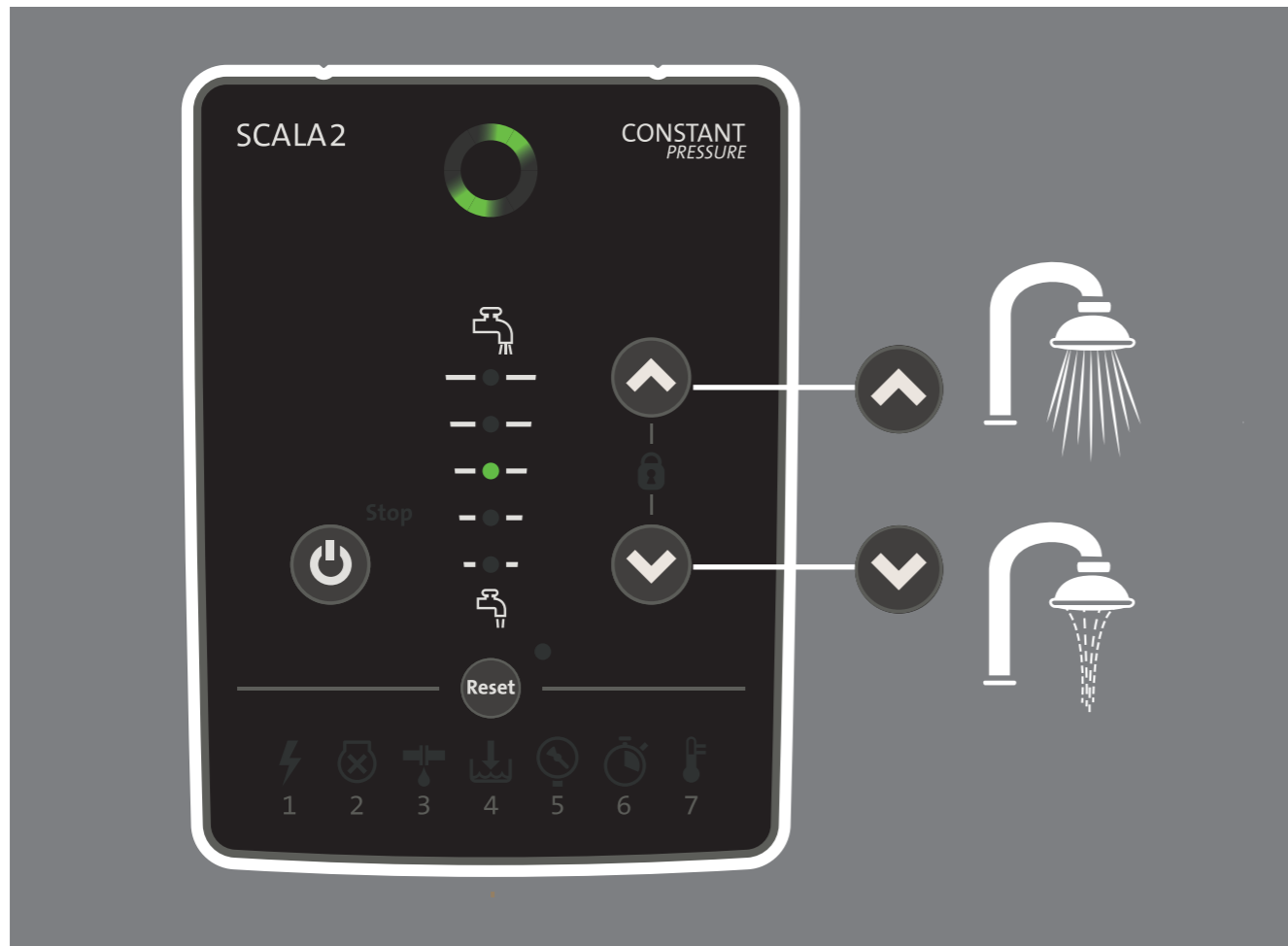
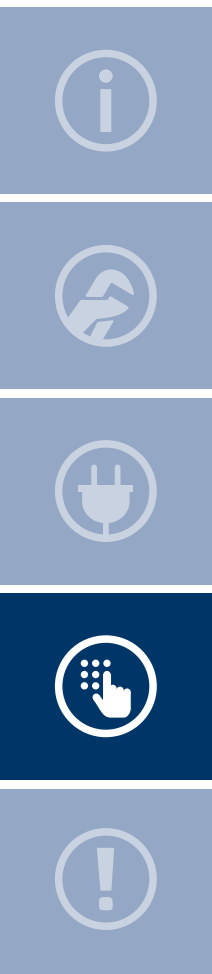

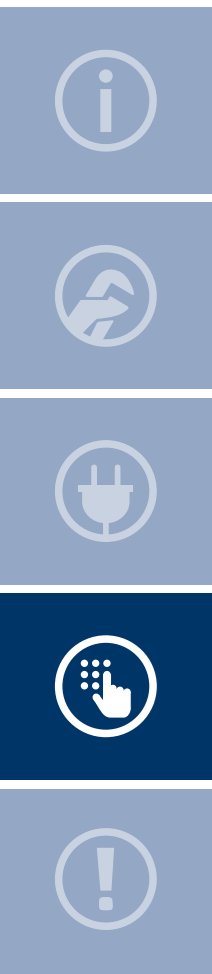

	BAR	PSI	Water colum [m]	kPa	MPa
	5.5	80	55	550	0.55
	5.0	73	50	500	0.50
	4.5	65	45	450	0.45
	4.0	58	40	400	0.40
	3.5	51	35	350	0.35
	3.0	44	30	300	0.30
	2.5	36	25	250	0.25
	2.0	30	20	200	0.20
	1.5	22	15	150	0.15



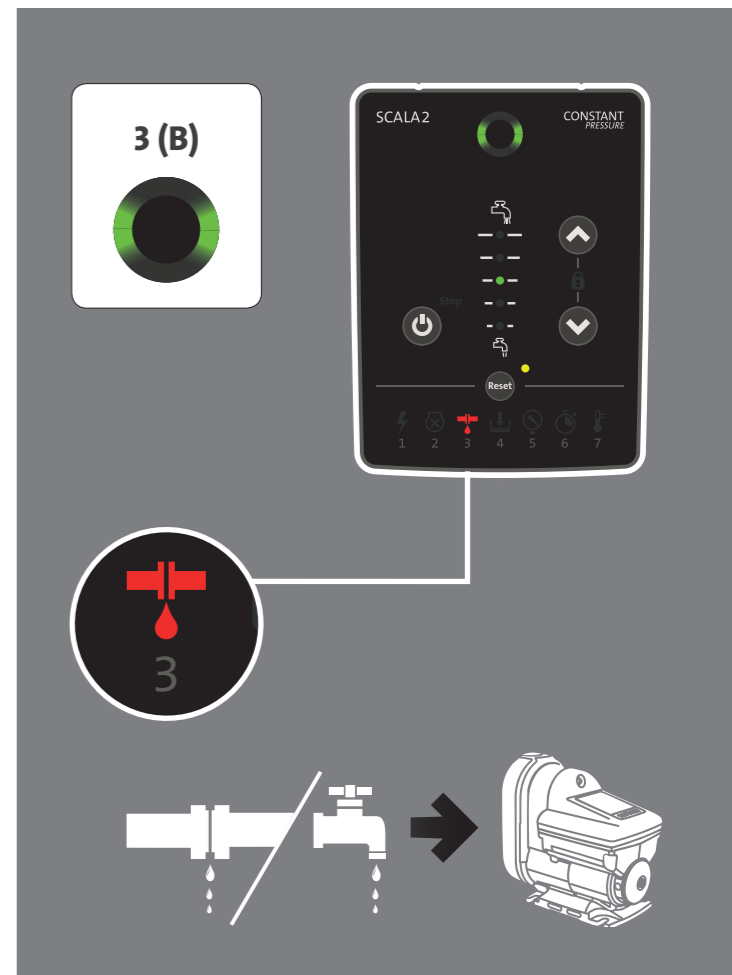
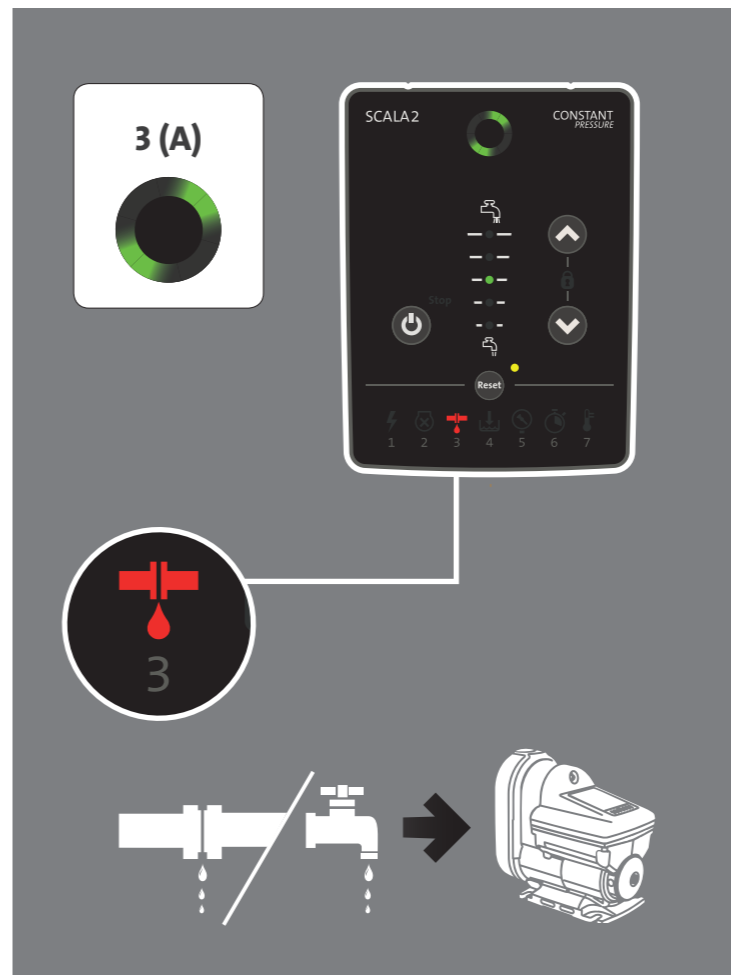
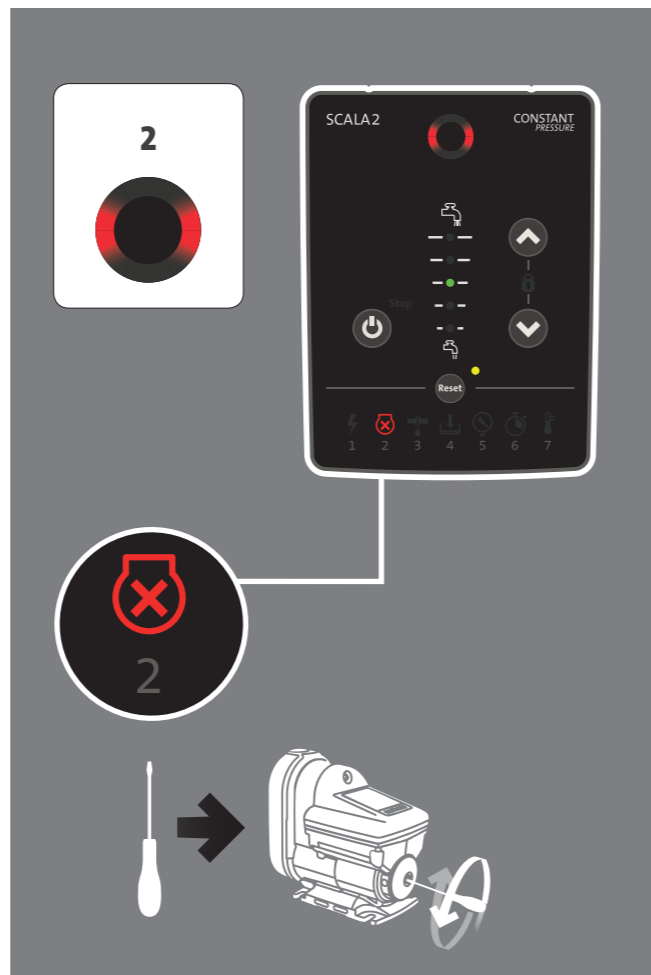
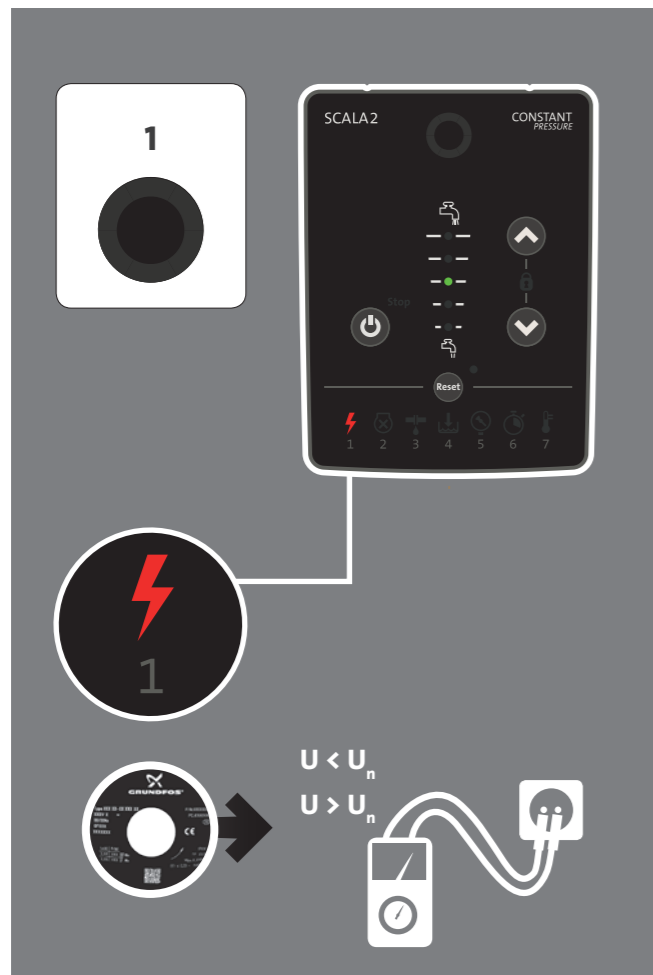
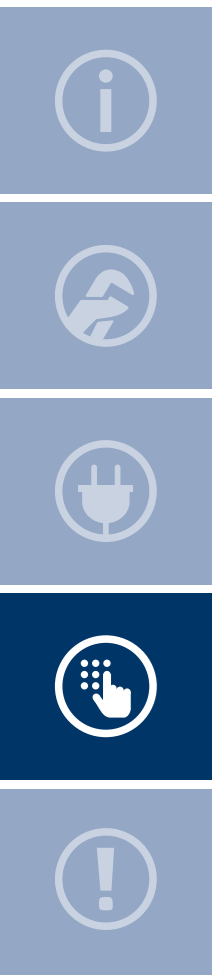

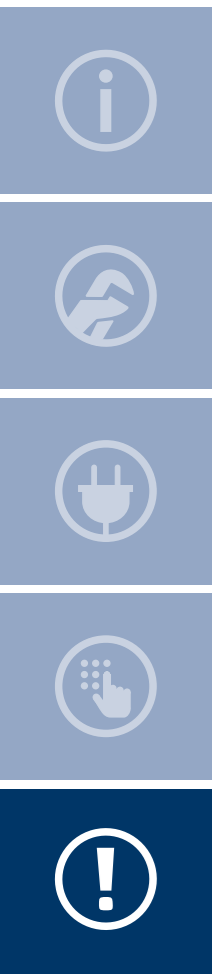

4

4

20

5

5

$p > p_{syst. max.}$
 $Pset > Hmax$

21

6

6

0.5 hr.

21

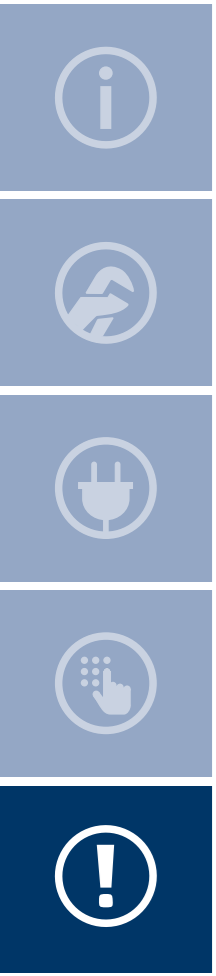

7 (A)

SCALA2 CONSTANT PRESSURE

7

22

7 (B)

SCALA2 CONSTANT PRESSURE

7

23

GRUNDFOS X

1 2 3 4 5 6 7

net.grundfos.com/qr/i/98880508

23

be think innovate

98501666 0615

ECM: 1158338

GRUNDFOS Holding A/S
Poul Due Jensens Vej 7
DK-8850 Bjerringbro
Tel: +45 87 50 14 00
www.grundfos.com

GRUNDFOS 

The name Grundfos, the Grundfos logo, and be think innovate are registered trademarks owned by Grundfos Holding A/S or Grundfos A/S, Denmark. All rights reserved worldwide.